

Handheld meter Cond 330i/340i

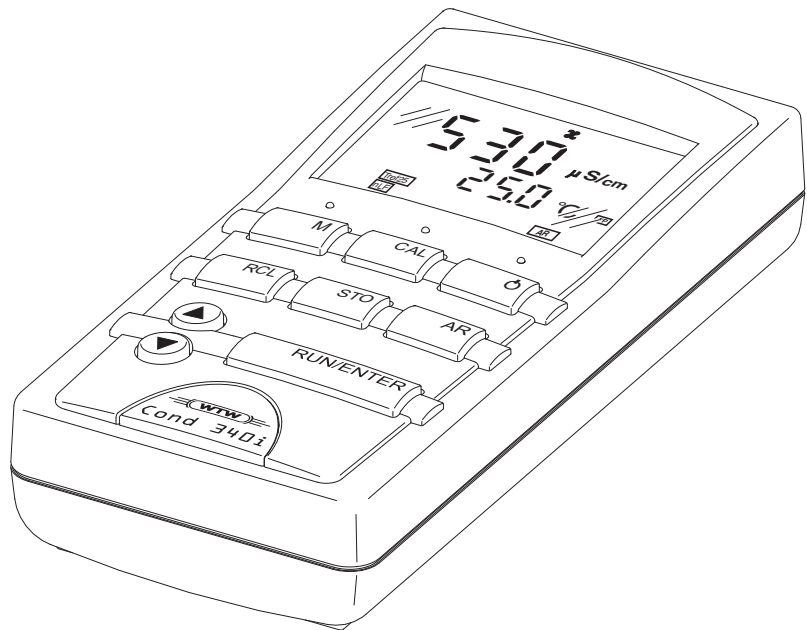

Conductivity measuring instrument

Accuracy when going to press

The use of advanced technology and the high quality standard of our instruments are the result of continuous development. This may result in differences between this operating manual and your instrument. Also, we cannot guarantee that there are absolutely no errors in this manual. Therefore, we are sure you will understand that we cannot accept any legal claims resulting from the data, figures or descriptions.

Warranty

We guarantee the instrument described for 3 years from the date of purchase.

The instrument warranty covers manufacturing faults that are discovered within the warranty period. The warranty does not cover components that are replaced during maintenance work, e.g. batteries.

The warranty claim extends to restoring the instrument to readiness for use but not, however, to any further claim for damages. Improper handling or unauthorized opening of the instrument invalidates any warranty claim.

To ascertain the warranty liability, return the instrument and proof of purchase together with the date of purchase freight paid or prepaid.

Copyright

© Weilheim 2008, WTW GmbH
Reproduction in whole - or even in part - is prohibited without the express written permission of WTW GmbH, Weilheim.
Printed in Germany.

- 1 Overview 5**
 - 1.1 SETs of equipment 6
 - 1.2 Keypad 7
 - 1.3 Display 8
 - 1.4 Jack field 8

- 2 Safety 9**
 - 2.1 Authorized use 9
 - 2.2 General safety instructions 10

- 3 Commissioning 11**
 - 3.1 Scope of delivery 11
 - 3.2 Initial commissioning 11

- 4 Operation 13**
 - 4.1 Switching on the measuring instrument 13
 - 4.2 Measuring 14
 - 4.2.1 General information 14
 - 4.2.2 Conductivity / Specific resistance 15
 - 4.2.3 Salinity 15
 - 4.2.4 TDS (Total dissolved solids) 16
 - 4.3 Determining/setting up the cell constant [C] 18
 - 4.3.1 Determining the cell constant (calibrating in the control standard) 20
 - 4.3.2 Setting the cell constant manually 22
 - 4.3.3 Setting the temperature compensation TC 25
 - 4.4 Saving 29
 - 4.4.1 Saving manually 29
 - 4.4.2 Saving automatically 31
 - 4.4.3 Outputting the data storage 33
 - 4.4.4 Clearing the memory 37
 - 4.5 Transmitting data (only Cond 340i) 38
 - 4.5.1 Data transmission interval (Int 2, Cond 340i) 38
 - 4.5.2 Recorder (analog output, Cond 340i) 40
 - 4.5.3 PC/external printer (RS 232 interface, Cond 340i) 41
 - 4.5.4 Remote control (Cond 340i) 41
 - 4.6 Configuration 42
 - 4.7 Reset 46

- 5 Maintenance, cleaning, disposal 49**
 - 5.1 Maintenance 49
 - 5.2 Cleaning 50
 - 5.3 Disposal 50

6	What to do if...	51
7	Technical data	53
8	Lists	57

1 Overview

The compact precision handheld meter Cond 330i/340i enables you to carry out conductivity measurements rapidly and reliably.

The Cond 330i/340i handheld meter provides the maximum degree of operating comfort, reliability and measuring certainty for all applications.

The proven procedure for adjusting or setting the cell constant and the special *AutoRead* function support you in your work with the conductivity measuring instrument.

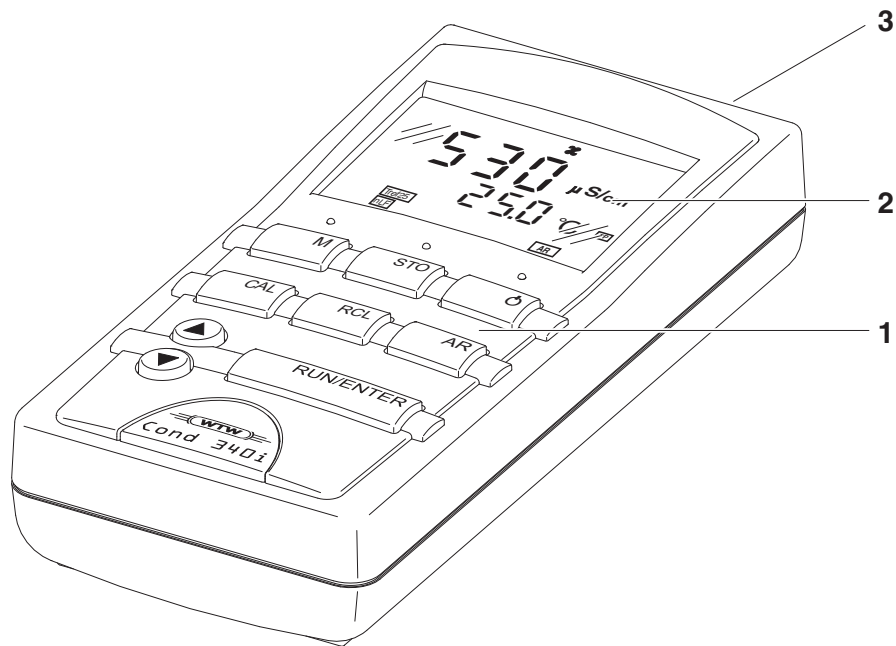

1	Keypad
2	Sample display
3	Jack field

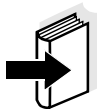

Note

If you need further information or application notes, you can obtain the following material from WTW:

- Application reports
- Primers
- Safety datasheets.

You will find information on available literature in the WTW catalog or via the Internet.

1.1 SETs of equipment

The measuring instrument is also available as part of individual SETs of equipment. You will find additional information on this and other accessories in the WTW catalog or via the Internet.

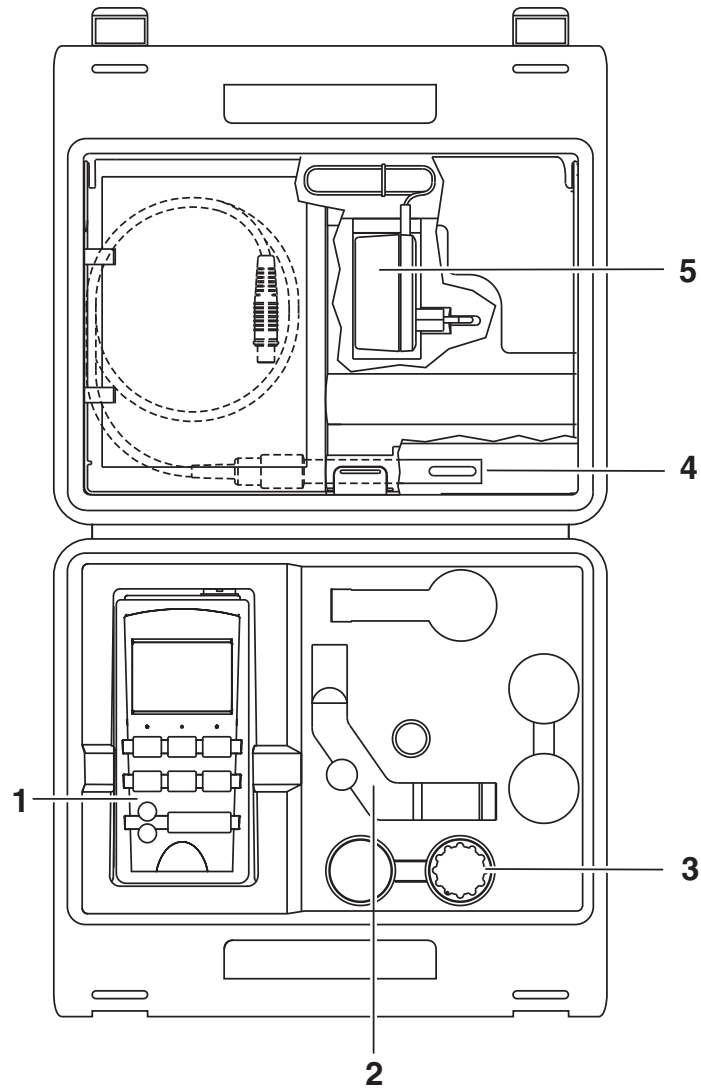







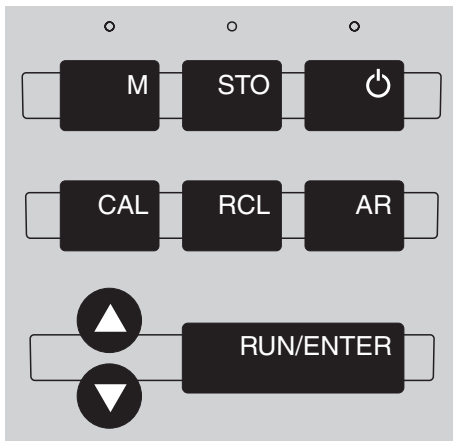

Set (sample configuration):

1	Measuring instrument, Cond 330i/340i
2	Stand
3	<ul style="list-style-type: none"> – 50 ml control standard for conductivity measuring cells – Beaker, 50 ml
4	Conductivity measuring cell
5	Plug-in power supply, optional (340i only)

1.2 Keypad



Key functions

	Select the measuring mode <M> : <ul style="list-style-type: none"> – Conductivity/Specific resistance – Salinity – Total dissolved solids (TDS)
	Save a measured value <STO>
	Switch measuring instrument on/off <ON/OFF>
	<ul style="list-style-type: none"> – Determine or set up the cell constant – Select temperature compensation <CAL>
	Display/transmit measured values <RCL>
	Activate/deactivate the AutoRead function <AR>
	Increase values, scroll <▲ >
	Decrease values, scroll <▼ >
	Confirm entries, start AutoRead <RUN/ENTER>

1.3 Display

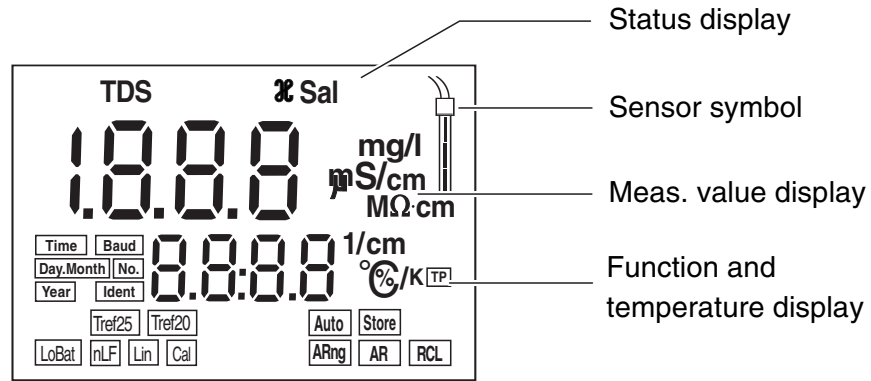

1.4 Jack field

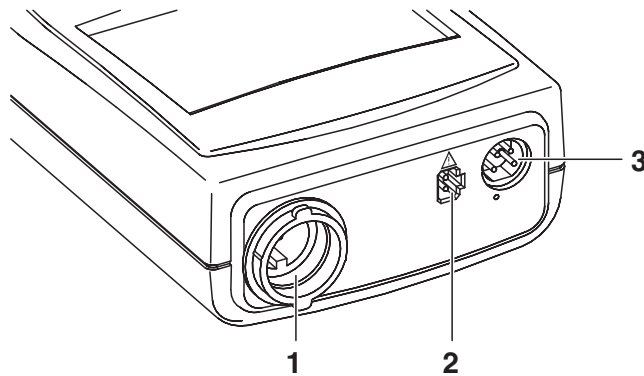

1	TetraCon 325 conductivity measuring cell
2	Plug-in power supply (optional) - Cond 340i only
3	Serial interface RS 232 - Cond 340i only



Warning

Only connect conductivity measuring cells to the measuring instrument that cannot return any voltages or currents that are not allowed (> SELV and > current circuit with current limiting). Nearly all measuring cells - especially WTW measuring cells - fulfill these conditions.

2 Safety

This operating manual contains basic instructions that you must follow during the commissioning, operation and maintenance of the conductivity measuring instrument. Consequently, all responsible personnel must read this operating manual before working with the measuring system. The operating manual must always be available within the vicinity of the measuring system.

Target group

The measuring instrument was developed for work in the field and in the laboratory.

We assume that, as a result of their professional training and experience, the operators will know the necessary safety precautions to take when handling chemicals.

Safety instructions



The individual chapters of this operating manual use safety instructions such as the label shown below to indicate various hazards or dangers:

Warning

indicates instructions that must be followed precisely in order to avoid the possibility of slight injuries or damage to the instrument or the environment.

Further notes



Note

indicates notes that draw your attention to special features.

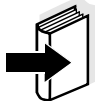

Note

indicates cross-references to other documents, e.g. operating manuals.

2.1 Authorized use

The authorized use of the measuring instrument consists exclusively of the measurement of conductivity, salinity, temperature and TDS (total dissolved solids) in the field and laboratory.

The technical specifications as given in chapter 7 TECHNICAL DATA must be observed. Only the operation and running of the measuring instrument according to the instructions given in this operating manual is authorized.

Any other use is considered to be **unauthorized**.

2.2 General safety instructions

This instrument is built and inspected according to the relevant guidelines and norms for electronic measuring instruments (see chapter 7 TECHNICAL DATA).

It left the factory in a safe and secure technical condition.

Function and operating safety

The smooth functioning and operational safety of the measuring instrument can only be guaranteed if the generally applicable safety measures and the specific safety instructions in this operating manual are followed during operation.

The smooth functioning and operational safety of the measuring instrument can only be guaranteed under the environmental conditions that are specified in chapter 7 TECHNICAL DATA.

If the instrument was transported from a cold environment to a warm environment, the formation of condensate can lead to the faulty functioning of the instrument. In this event, wait until the temperature of the instrument reaches room temperature before putting the instrument back into operation.

Safe operation

If safe operation is no longer possible, the instrument must be taken out of service and secured against inadvertent operation!

Safe operation is no longer possible if the measuring instrument:

- has been damaged in transport
- has been stored under adverse conditions for a lengthy period of time
- is visibly damaged
- no longer operates as described in this manual.

If you are in any doubt, please contact the supplier of the instrument.

Obligations of the purchaser

The purchaser of the measuring instrument must ensure that the following laws and guidelines are observed when using dangerous substances:

- EEC directives for protective labor legislation
- National protective labor legislation
- Safety regulations
- Safety datasheets of the chemical manufacturers.

3 Commissioning

3.1 Scope of delivery

- Handheld meter, Cond 330i or 340i
- Plug-in power supply, optional (340i only)
- Operating manual and short operating manual
- 4 batteries, 1.5 V Mignon type AA (in the instrument)

3.2 Initial commissioning

Perform the following activities:

- Set the date and time
- Connect the plug-in power supply, optional (340i only)

Setting the date and time

1	Press the <M> key and hold it down.
2	Press the <ON/OFF> key. The display test appears briefly on the display.
3	Press the <RUN/ENTER> key repeatedly until the date appears on the display.
4	Set the date of the current day with <▲> <▼> .
5	Confirm with <RUN/ENTER> . The date (month) flashes in the display.
6	Set the current month with <▲> <▼> .
7	Confirm with <RUN/ENTER> . The year appears on the display.
8	Set the current year with <▲> <▼> .
9	Confirm with <RUN/ENTER> . The hours flash on the display.
10	Set the current time with <▲> <▼> .
11	Confirm with <RUN/ENTER> . The minutes flash on the display.
12	Set the current time with <▲> <▼> .
13	Confirm with <RUN/ENTER> . The instrument switches to the measuring mode.
14	Switch the instrument off using <ON/OFF> .

Connecting the plug-in power supply (340i)

You can either operate the measuring instrument with batteries or with the plug-in power supply. The plug-in power supply supplies the conductivity measuring instrument 340i with low voltage (12 V DC). This saves the batteries.



Warning

The line voltage at the operating site must lie within the input voltage range of the original plug-in power supply (see chapter 7 TECHNICAL DATA).



Warning

Use original plug-in power supplies only (see chapter 7 TECHNICAL DATA).

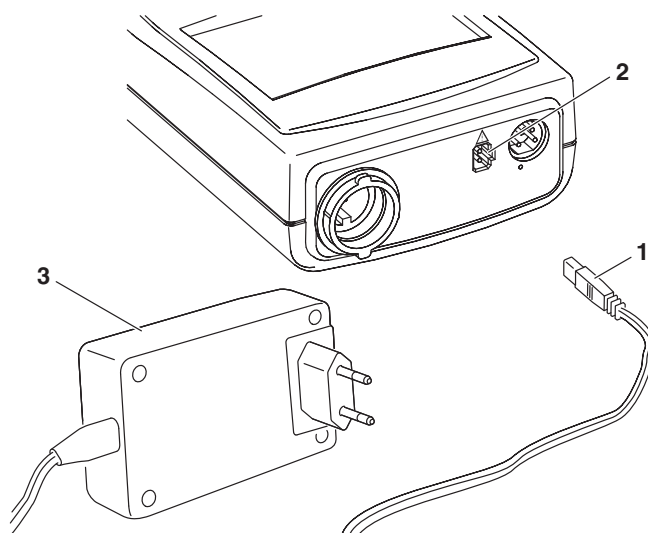

- | | |
|---|---|
| 1 | Plug the jack (1) into the socket (2) of the measuring instrument. |
| 2 | Connect the original WTW plug-in power supply (3) to an easily accessible mains socket. |



Note

You can also measure without the plug-in power supply.

4 Operation

4.1 Switching on the measuring instrument

1	Connect a conductivity measuring cell to the measuring instrument.
2	Press the <ON/OFF> key. The display test appears briefly on the display. Subsequently, the selected cell constant and the temperature compensation that was set up appear for approx. one second one after the other. The measuring instrument then automatically switches to the measuring mode that was last selected.



Note

The measuring instrument has an energy saving feature to avoid unnecessary battery depletion. The energy saving feature switches the measuring instrument off if no key has been pressed for an hour. The energy saving feature is not active when the AutoStore function is active.

Measuring instrument 340i

The energy saving feature is also not active

- if the power is supplied by the plug-in power supply,
- if the communication cable and a PC with a running communication program are connected,
- if the recorder cable is connected,
- if the printer cable is connected (for external printers).

4.2 Measuring

4.2.1 General information

Preparatory activities

Perform the following preparatory activities when you want to measure:

1	Connect the conductivity measuring cell to the measuring instrument.
2	In conjunction with the measuring cell, check or calibrate the measuring instrument. How to calibrate is described in section 4.3.
3	Select the measuring mode with <M> .



Warning

When connecting an earthed PC/printer, measurements cannot be performed in earthed media as incorrect values would result. The RS 232 interface is not galvanically isolated.

Temperature sensor

Only carry out measurements with a temperature sensor. The temperature sensor is shown on the display by *TP*.

The WTW TetraCon 325 conductivity measuring cell has a temperature sensor integrated in it.



Note

The conductivity measuring instrument automatically recognizes the type of the temperature sensor used. This enables to connect measuring cells with the NTC30 or Pt1000.

Temperature compensation

The instrument has a nonlinear temperature compensation that can be switched off (see section 4.3.3 SETTING THE TEMPERATURE COMPENSATION TC).

Reference temperature, Tref

The reference temperature (*Tref*) can be switched between 20 °C and 25 °C. It appears on the display as *Tref20* or *Tref25*. To switch over the reference temperature, see section 4.6 CONFIGURATION.

4.2.2 Conductivity / Specific resistance



Note

You can display measured values in the units $\mu\text{S}/\text{cm}$ (conductivity) or $\text{M}\Omega\text{cm}$ (specific resistance). This setting is described in section 4.6 CONFIGURATION.

Thus, you can carry out conductivity measurements or measurements of the specific resistance:

1	Perform the preparatory activities according to section 4.2.1.
2	Immerse the conductivity measuring cell in the test sample.
3	Press the <M> key until \mathcal{K} appears on the status display. Depending on the setting, one of the following display indicators appears on the display:

Conductivity
 $\mu\text{S}/\text{cm}$

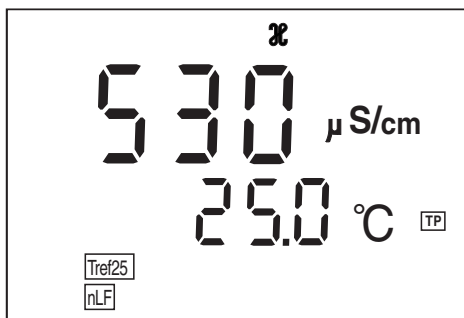

Specific resistance
 $\text{M}\Omega\text{cm}$

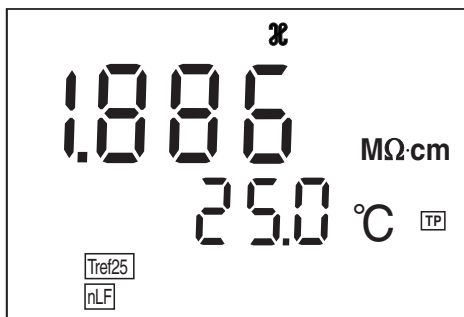

4	Wait for a stable measured value.
---	-----------------------------------

4.2.3 Salinity

You can measure the salinity as follows:

1	Perform the preparatory activities according to section 4.2.1.
2	Immerse the conductivity measuring cell in the test sample.

- 3 Press the **<M>** key until *Sal* appears on the status display. The salinity value appears on the display.

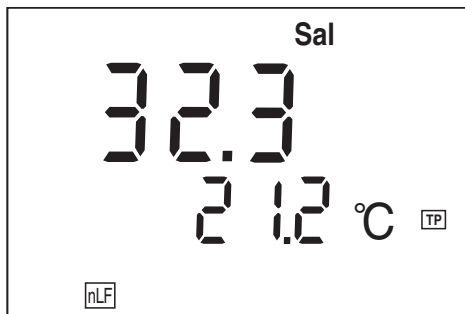

- 4 Wait for a stable measured value.

4.2.4 TDS (Total dissolved solids)

You can measure the total dissolved solids as follows:

- 1 Perform the preparatory activities according to section 4.2.1.
- 2 Immerse the conductivity measuring cell in the test sample.
- 3 Press the **<M>** key until *TDS* appears on the status display. The value of the total dissolved solids appears in the upper display line. The TDS factor appears in the lower display line.

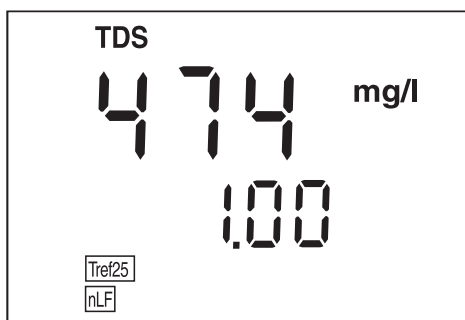

- 4 Using **<▲>** **<▼>**, set the TDS factor (0.40 ... 1.00). (The TDS factor has to be determined by a comparison measurement before.)

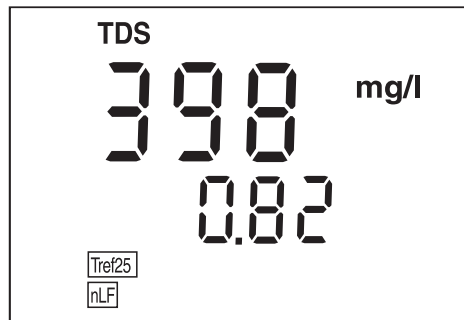

- 5 | Wait for a stable measured value.

AutoRead AR (drift control)

The AutoRead function (drift control) checks the stability of the measurement signal. The stability has a considerable effect on the reproducibility of the measured value.

- 1 | Select the required measuring mode with **<M>**.
- 2 | Activate the AutoRead function with **<AR>**.
The current measured value is frozen (hold function).
- 3 | Start AutoRead with **<RUN/ENTER>**.
AR flashes until a stable measured value is reached.

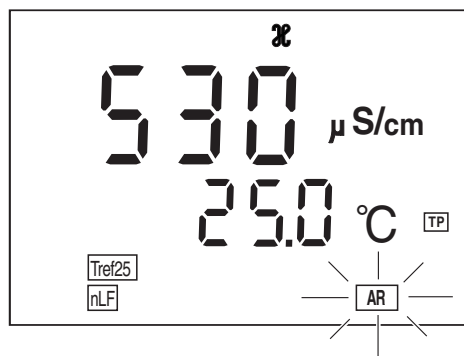

- 4 | If necessary, start the next AutoRead measurement with **<RUN/ENTER>**.
- 5 | To terminate AutoRead: Press the **<AR>** key.



Note

The current AutoRead measurement can be terminated at any time (accepting the current value) by pressing **<RUN/ENTER>**.

4.3 Determining/setting up the cell constant [C]

Why determine/set up the cell constant?

Aging slightly changes the characteristics of the cell, e. g. by coatings. As a result, an inexact measured value is displayed. The original characteristics of the cell can often be restored by cleaning the cell. Calibration determines the current cell constant and stores it in the instrument.

Thus, you should calibrate at regular intervals (we recommend: every 6 months).

Procedure

The cell constant is determined in the control standard, 0.01 mol/l KCl.

You can determine the actual cell constant of the conductivity measuring cell by calibrating with the control standard in the following ranges:

- 0.450 ... 0.500 cm⁻¹
(e.g. TetraCon, nominal cell constant 0.475)
- 0.800 ... 1.200 cm⁻¹
(cells with a cell constant of approx. 1)

Besides, you can set the cell constant manually in the following ranges:

- 0.090 ... 0.110 cm⁻¹
- 0.250 ... 2.500 cm⁻¹

The fixed cell constant, 0.010 cm⁻¹ can also be selected. It is not necessary to calibrate or adjust it.

Cell constants outside the above mentioned ranges cannot be calibrated.

Printing the calibration record (340i)

The calibration protocol contains the calibration data of the current calibration. You can transmit the calibration protocol to a printer via the serial interface (see page 36).



Note

You can automatically print a calibration protocol after the calibration. To do so, connect a printer to the interface according to section 4.5.3 before calibrating. After a valid calibration, the record is printed.

Sample printout:

```

CALIBRATION PROTOCOL
 14.04.01      11:37
Device No.: 99990000
Calibration Conductivity
Cal time: 14.04.01 / 11:37
Cal interval: 180d
Cal Std.: 0.01 mol/l KCL
           40.0 °C
Conduct./Tref25: 1413µS/cm
Cell Const : 0.478 1/cm
Probe :      +++
    
```

Calibration evaluation

After the calibration, the measuring instrument automatically evaluates the current status of the calibration. The evaluation appears on the display.

Display	Cell constant [cm ⁻¹]
	0.450 ... 0.500 cm ⁻¹ 0.800 ... 1.200 cm ⁻¹
E3 Eliminate the error according to chapter 6 WHAT TO DO IF...	outside the ranges 0.450 ... 0.500 cm ⁻¹ or 0.800 ... 1.200 cm ⁻¹

4.3.1 Determining the cell constant (calibrating in the control standard)



Note

This method of automatically determining the cell constant by calibration with the 0.01 mol/l KCL standard solution can only be used for measuring cells with cell constants in the range 0.450 ... 0.500 cm⁻¹ or 0.800 ... 1.200 cm⁻¹.

This is how you can determine the cell constant:

- 1 Press the <CAL> key until *CELL* appears on the display.

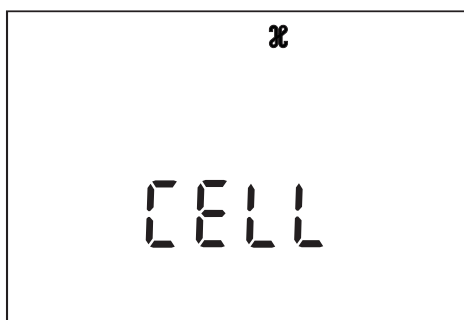

- 2 Press the <RUN/ENTER> key.

- 3 Press the <CAL> repeatedly, until the calibrated cell constant appears on the display: *CAL* appears on the display.

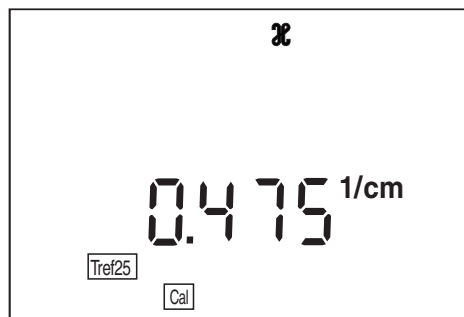

- 4 The displayed value is the current, calibrated cell constant. You can:
 - accept this setting for measuring with <M> or
 - continue with step 5 and start a new calibration.

- 5 Immerse the measuring cell in the control standard solution, 0.01 mol/KCl.

- 6 Press the **<RUN/ENTER>** key.
- If no temperature sensor is connected, enter the current temperature of the solution with **<▲>** **<▼>** and confirm with **<RUN/ENTER>**.
 - If a temperature sensor is connected, the AR measurement to determine the cell constant starts.

The AR display indicator flashes until a stable signal is reached. The cell constant determined is displayed. The measuring instrument automatically stores the cell constant.

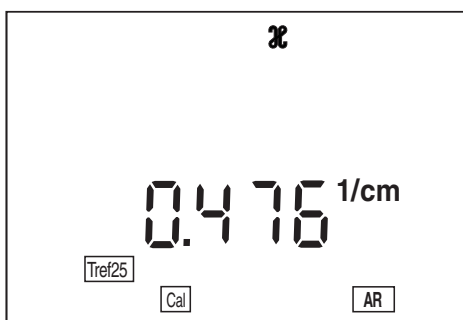
**Note**

If the error message **E3** appears, refer to chapter 6 WHAT TO DO IF...

- 7 Switch to the measuring mode with **<M>** or **<RUN/ENTER>** .

4.3.2 Setting the cell constant manually



Note

The cell constant to be set must either be taken from the operating manual of the measuring cell or is printed on the measuring cell.

You can set the cell constant manually as follows:

Range
0.250 ... 2.500 cm⁻¹

- 1 Press the <CAL> key repeatedly until *CELL* appears on the display.

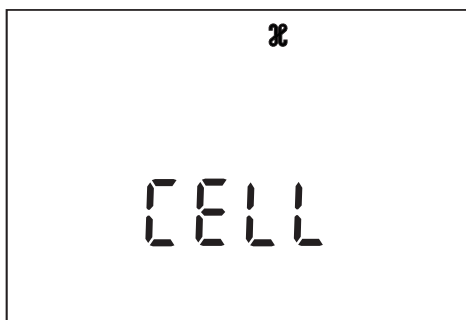

- 2 Press the <RUN/ENTER> key.

- 3 Press the <CAL> repeatedly until the adjustable cell constant, e.g. 0.278 cm⁻¹ appears.

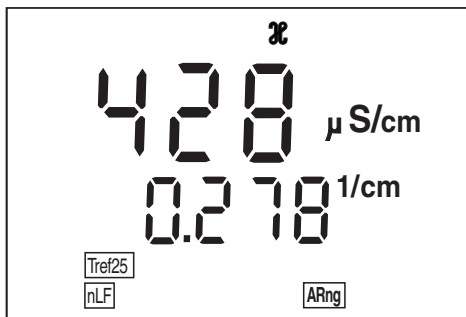

- 4 Set the cell constant to be used with <▲> <▼> , e.g. 0.614 cm⁻¹.

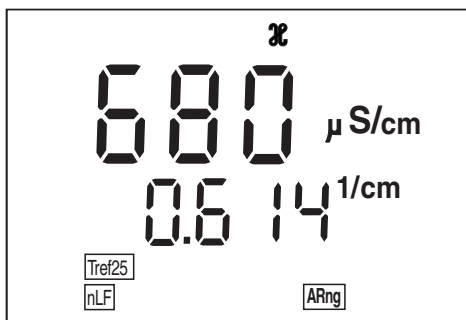

Range
0.090 ... 0.110 cm⁻¹

- To return to the measuring mode: Press the **<M>** key.
From now on, the cell constant 0.614 cm⁻¹ will be used.

- Press the **<CAL>** key repeatedly until *CELL* appears on the display.

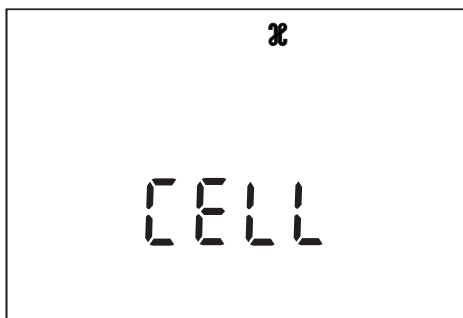

- Press the **<RUN/ENTER>** key.
- Press the **<CAL>** key repeatedly until a cell constant in the range 0.090 ... 0.110 cm⁻¹ appears on the display.

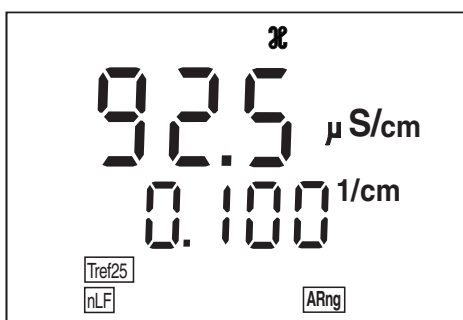

- Set the cell constant to be used with **<▲>** **<▼>**, e.g. 0.105 cm⁻¹.

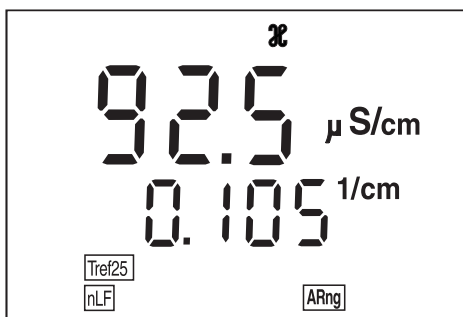

- To return to the measuring mode: Press the **<M>** key. Now this setting is accepted for measuring.

**Setting the fixed
cell constant
0.010 cm⁻¹**

You can set the fixed value 0.010 cm⁻¹ for the cell constant as follows:

- 1 Press the **<CAL>** key repeatedly until *CELL* appears on the display.

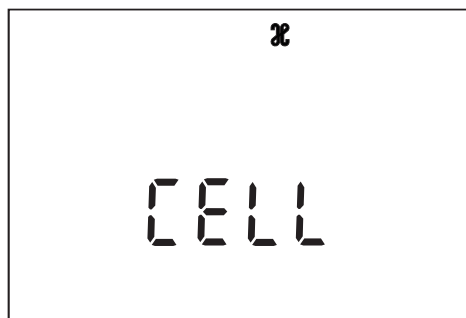

- 2 Press the **<RUN/ENTER>** key.
- 3 Press the **<CAL>** key repeatedly until the cell constant 0.010 cm⁻¹ appears on the display.

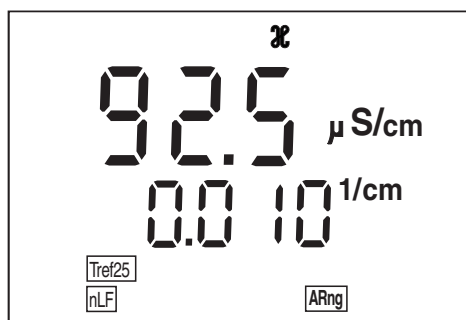

- 4 To return to the measuring mode: Press the **<M>** key.
From now on, the cell constant 0.010 cm⁻¹ will be used.

4.3.3 Setting the temperature compensation TC

The calculation of the temperature compensation is based on the preset reference temperature, Tref 20 or Tref 25 (see section 4.6 CONFIGURATION).

You can select one of the following temperature compensation methods:

- **Nonlinear temperature compensation (nLF)** according to EN 27 888
- **Linear temperature compensation (Lin)** with selectable coefficients of 0.001 ... 3.000 %/K
- **No temperature compensation (- - -)**



Note

Select the following temperature compensations given in the table according to the respective test sample:

Application tips

Test sample	Temperature compensation (TC)	Display indicator
Natural water (ground water, surface water and drinking water)	nLF according to DIN 38404 EN 27 888	nLF
Ultrapure water	nLF according to DIN 38404 EN 27 888	nLF
Other aqueous solutions	Set linear temperature coefficient 0.001 ... 3.000 %/K	Lin
Salinity (seawater)	Automatically nLF according to IOT	Sal, nLF

**Selecting the
nonlinear
temperature
compensation**

You can select the nonlinear temperature compensation as follows:

- 1 Press the **<CAL>** key repeatedly until *tc* appears on the display.

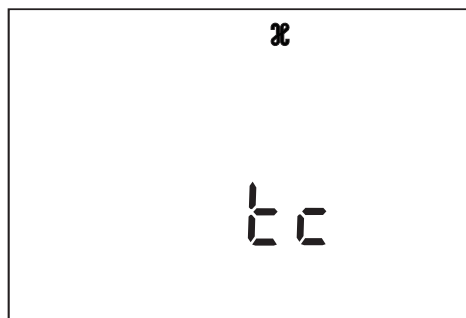

- 2 Press the **<RUN/ENTER>** key.
- 3 Press the **<CAL>** key repeatedly until *nLF* appears on the display.

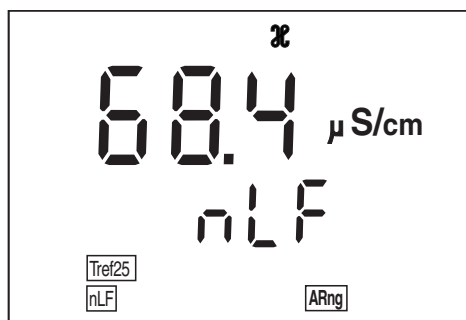

- 4 To return to the measuring mode: Press the **<M>** key. From now on, nLF will be used for the temperature compensation.

Selecting the linear temperature compensation

You can select the linear temperature compensation as follows:

- 1 Press the <CAL> key repeatedly until t_c appears on the display.

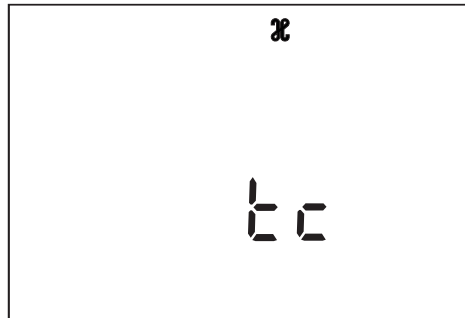

- 2 Press the <RUN/ENTER> key.

- 3 Press the <CAL> key repeatedly until the adjustable linear temperature coefficient appears on the display.

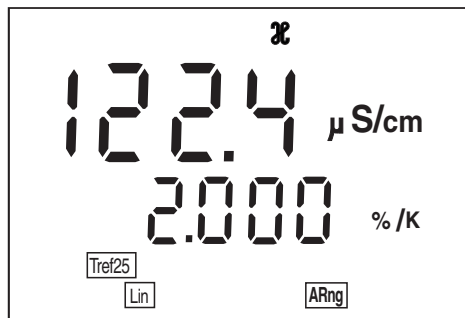

- 4 Set the temperature coefficient with <▲> <▼>, e.g. 1.880 %/K.

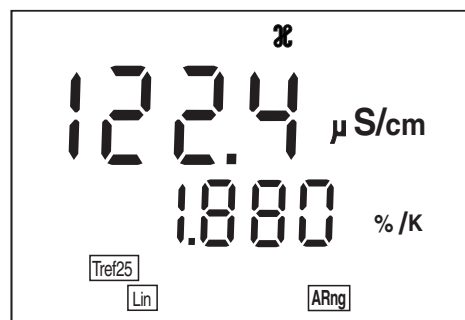

- 5 To return to the measuring mode: Press the <M> key. From now on, the adjusted linear temperature coefficient will be used for the temperature compensation.

Switching the temperature compensation off

You can switch off the temperature compensation as follows:

- 1 Press the <CAL> key repeatedly until *tc* appears on the display.

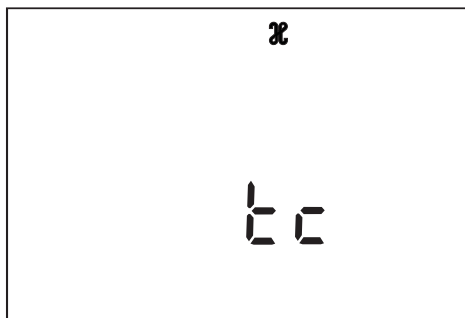

- 2 Press the <RUN/ENTER> key.
- 3 Press the <CAL> key repeatedly until the following display appears.

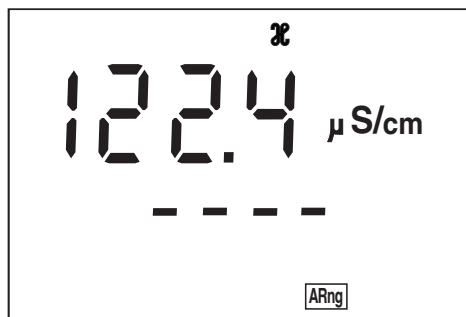

- 4 The temperature compensation is switched off.
- 5 To return to the measuring mode: Press the <M> key. From now on, the instrument will measure without temperature compensation.

4.4 Saving

The measuring instrument has an internal data memory. It can store up to 800 data records.

A complete data record consists of:

- Storage location
- Date/time
- Measured value
- Temperature
- Temperature measuring procedure
- ID number

You can transmit measured values (data records) to the data storage in two ways:

- Save manually
- Switch on AutoStore (Int 1).

4.4.1 Saving manually

You can transmit a measured value to the data storage as follows:

- 1 Press the **<STO>** key.
The current number (location number *No.*) of the next free storage location appears under the current measured value on the display.

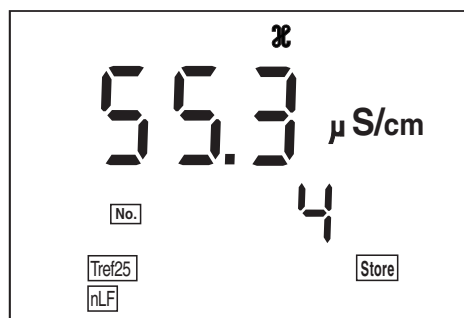

- 2 Confirm with **<RUN/ENTER>**.
The display switches to entering the ID number.

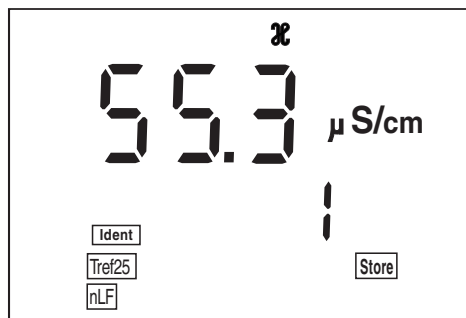

- | | |
|---|---|
| 3 | Using <▲> <▼>, enter the required ID number (1 ... 999). |
| 4 | Confirm with <RUN/ENTER>. The instrument changes to the measuring mode. |

Message StoFull

This message appears when all of the 800 storage locations are occupied.

You have the following options:

Saving the current measured value. The oldest measured value (storage location 1) will be overwritten by this	Press <RUN/ENTER>.
Returning to the measuring mode without saving	press any key
Outputting the data storage	see section 4.4.3
Clearing the memory	see section 4.4.4

4.4.2 Saving automatically

The save interval (Int 1) determines the chronological interval between automatic save processes.

After the fixed interval has expired, the current data record is transmitted to the storage and to the interface.

Setting the save interval

The default setting for the save interval (Int 1) is OFF.

By this, the AutoStore function is switched off.

To switch the function on, set an interval (5 s, 10 s, 30 s, 1 min, 5 min, 10 min, 15 min, 30 min, 60 min):

- 1 Press the <RUN/ENTER> key and hold it down.
- 2 Press the <STO> key. *Int 1* appears on the display.



- 3 Set the required interval between the saving procedures with <▲> <▼>.
- 4 Confirm with <RUN/ENTER>. The number of free memory locations appears on the display.



- | | |
|---|--|
| 5 | As soon as all of the 800 storage locations are occupied, <i>AutoStore</i> is terminated (Int 1 = OFF).
If there are not enough storage locations available for your measurements:
<ul style="list-style-type: none"> – Output and backup the data storage (see page 33) and – clear the memory (see page 37). |
| 6 | Confirm with <RUN/ENTER> .
The prompt for the ID number appears on the display. |

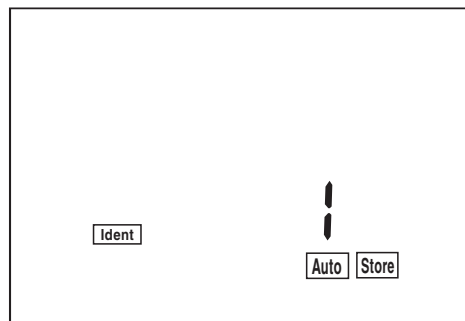

- | | |
|---|---|
| 7 | Set the required ID number with <▲> <▼> . |
| 8 | Confirm with <RUN/ENTER> .
The instrument switches to the measuring mode and starts the measuring and saving process.
<i>AutoStore</i> flashes on the display. |

**Note**

The *AutoStore* function is interrupted if you start other functions, e.g. output the data storage.

After the function is finished, the *AutoStore* function is continued. By this, however, temporal gaps in the recording of the measured values will occur.

**Switching off
AutoStore**

Switch *AutoStore* off by:

- setting the save interval (Int 1) to OFF, or
- switching the measuring instrument off and then on again.

4.4.3 Outputting the data storage

You can output the contents of the data storage:

- Stored data on the display
- Calibration data on the display
- Stored data on the serial interface (only Cond 340i)
- Calibration protocol to the interface (only Cond 340i)

Outputting stored data on the display

1 Press the **<RCL>** key repeatedly until *StO dISP* appears on the display.



2 Press the **<RUN/ENTER>** key.
A measured value appears on the display.
The storage location of the data record is displayed for approx. 2 s, then the respective temperature appears.

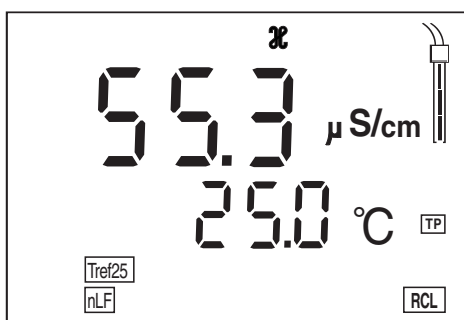

You can perform the following activities:

Display further elements of the data record (ID number, date, time, storage location)	Press <RUN/ENTER>
Advance one data record (storage location)	Press <▲>
Go back one data record (storage location)	Press <▼>

**Note**

If you want to search for a certain element (e.g. date), proceed as follows:

- | | |
|---|---|
| 1 | Using <RUN/ENTER> , select the element (e.g. date). |
| 2 | Press <▲> or <▼> repeatedly until the required date appears on the display.
After approx. 2 s the temperature of the displayed measured value appears. |

Outputting stored data to the interface (only Cond 340i)

- | | |
|---|--|
| 1 | Press the <RCL> key repeatedly until <i>Sto SEr</i> appears on the display. |
|---|--|



- | | |
|---|---|
| 2 | Press the <RUN/ENTER> key.
The complete storage content is transmitted to the interface; during the data transmission the numbers of the currently transmitted storage locations run through. After the data transmission, the measuring instrument automatically switches to the measuring mode. |
|---|---|

**Note**

You can cancel the transmission with **<M>** or **<RUN/ENTER>**.

After the instrument number, the printout contains the complete storage contents in ascending order of the storage location numbers.

Sample printout:

```

Device No.: 99990000

No.      1:
  01.01.99      00:04
    2.40 mS/cm    25 °C
Tman
nLF
Tref25 C = 0.475 1/cm
Ident : 1

No.      2:
  10.01.99      10:09
    2.40 mS/cm    25.3 °C
Tauto
nLF
Tref25 C = 0.475 1/cm
Ident : 1

No.      3:
  12.01.99      01:48
    2.40 mS/cm    21.6 °C
Tauto
nLF
Tref25 C = 0.475 1/cm
Ident : 1
...

```

Outputting the calibration data on the display

- 1 Press the **<RCL>** key repeatedly until *CAL DISP* appears on the display.



- 2 Press the **<RUN/ENTER>** key.
The cell constant appears on the display, but the *CAL* display only appears when the displayed value was determined by calibrating the measuring cell.

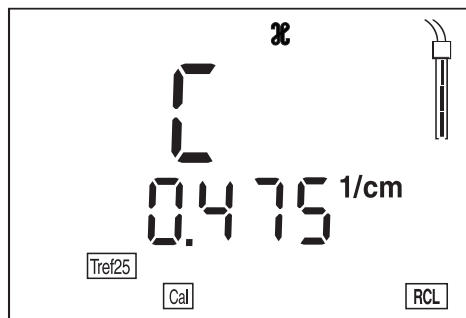

- 3 Using **<M>** or **<RUN/ENTER>**, you can switch back to the measuring mode.

Outputting the calibration protocol on the interface (only Cond 340i)

- 1 Press the **<RCL>** key repeatedly until *CAL* appears on the display.



- 2 Press the **<RUN/ENTER>** key.
The calibration protocol is transmitted to the interface.
After the data transmission, the measuring instrument automatically switches to the measuring mode.



Note

You will find a sample calibration protocol in PRINTING THE CALIBRATION RECORD (340i), page 18.

4.4.4 Clearing the memory

With this function, you can delete stored data records. 800 storage locations will then be available again.



Note

The *Clear memory* function only appears when there are data records stored in the memory. Otherwise, the measuring instrument automatically switches to the measuring mode.

Proceed as follows to clear all data records:

1	Switch off the measuring instrument.
2	Press the <STO> key and hold it down.
3	Press the <ON/OFF> key. The display test appears briefly on the display. Subsequently, <i>Sto clr</i> appears.



4	Confirm the clearing process with <RUN/ENTER> . Pressing any other key prevents the clearing, the data records will remain stored.
---	--



Note

The calibration data remain stored and can be called up.

4.5 Transmitting data (only Cond 340i)

You have the following possibilities of transmitting data:

- One of the following options:
 - With the *AutoStore* function (page 31), measured values are periodically saved internally (save interval Int 1) and output on the interface.
 - With the *Data transmission interval* function (Int 2), measured values are periodically output on the interface (see below).
- With the *Output data storage* function (page 33), calibration data or saved measured values are output on the interface.
- Via the analog recorder output (page 40), measured values are output as voltage values.
- With the KOM pilot communication kit (accessory), data can be transmitted bidirectionally (page 41).



Note

If you connect a recorder (analog output), the output on the digital interface is switched off.

4.5.1 Data transmission interval (Int 2, Cond 340i)

The interval to the data transmission (Int 2) determines the chronological interval between automatic data transmissions. After the selected interval expires, the current data record is transmitted to the interface.



Note

When the *AutoStore* function is active, the data transmission is performed according to the setting of the save interval (Int 1). Set the save interval (Int 1) to OFF to activate the *Data transmission* interval (Int 2).

**Setting the
Data transmission
interval**

The default setting for the interval is OFF.

To start the data transmission, set an interval (5 s, 10 s, 30 s, 1 min, 5 min, 10 min, 15 min, 30 min, 60 min):

- 1 Press the **<RUN/ENTER>** key and hold it down.
- 2 Press the **<RCL>** key. *Int 2* appears on the display.



- 3 Set the required interval between the saving procedures with **<▲>** **<▼>**.
- 4 Confirm with **<RUN/ENTER>**.
The measuring instrument automatically switches to the measuring mode.

4.5.2 Recorder (analog output, Cond 340i)

You can transmit data to a recorder via the analog output. Connect the analog output to the recorder via the AK323 interface cable. The data output automatically switches to *Recorder output*.

Socket assignment

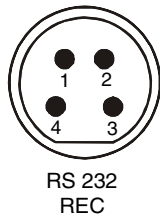

- 1 free
- 2 Plug coding
- 3 Ground
- 4 Analog output
(internal resistance < 5 Ohm)



Note

The analog output is activated automatically in the cable by connecting 2 and 3.

The signal range of the analog output depends on the measured variable and the measuring range:

Conductivity/ Resistance

Measuring range	Voltage	Resolution
0.000 ... 1.999 $\mu\text{S/cm}$	0 ... 1999 mV	1 mV
0.00 ... 19.99 $\mu\text{S/cm}$	0 ... 1999 mV	1 mV
0.0 ... 199.9 $\mu\text{S/cm}$	0 ... 1999 mV	1 mV
0 ... 1999 $\mu\text{S/cm}$	0 ... 1999 mV	1 mV
0.00 ... 19.99 mS/cm	0 ... 1999 mV	1 mV
0.0 ... 199.9 mS/cm	0 ... 1999 mV	1 mV
0 ... 500 mS/cm	0 ... 500 mV	1 mV

Salinity

Measuring range	Voltage	Resolution
0 ... 70.0	0 ... 700 mV	1 mV

TDS

Measuring range	Voltage	Resolution
0 ... 1999 mg/l	0 ... 1999 mV	1 mV

4.5.3 PC/external printer (RS 232 interface, Cond 340i)

Via the RS 232 interface, you can transmit the data to a PC or an external printer.

Use the AK340/B (PC) or AK325/S (ext. printer) cable to connect the interface to the instruments.

The data output automatically switches to the *RS 232* interface.



Warning

The RS 232 interface is not galvanically isolated.

When connecting an earthed PC/printer, measurements cannot be performed in earthed media as incorrect values would result.

Set up the following transmission data on the PC/printer:

Baud rate	selectable between: 1200, 2400, 4800 , 9600
Handshake	RTS/CTS + Xon/Xoff
Parity	none
Data bits	8
Stop bits	1

Socket assignment

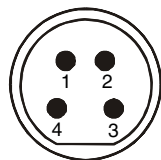

RS 232
REC

- 1 CTS
- 2 RxD
- 3 Ground
- 4 TxD

4.5.4 Remote control (Cond 340i)

The measuring instrument can be remotely controlled from a PC. This requires the KOM pilot communication kit. It is available as an accessory. The instrument is then controlled via commands that simulate keystrokes and request the current display contents.



Note

A more detailed description is provided within the scope of delivery of the communication kit.

4.6 Configuration

You can adapt the measuring instrument to your individual requirements. To do this, the following parameters can be changed (the status on delivery is marked in bold):

Baud rate	1200, 2400, 4800 , 9600
Calibration interval (Int 3)	1 ... 180 ... 999 d
AutoRange ARng	On or off
Reference temperature	– 25 °C (TREF25) – 20 °C (TREF20)
Display of the measured value as conductivity or specific resistance	S/cm or MΩ
Date/time	Any



Note

You can leave the configuration menu at any time with **<M>**. The parameters that have already been changed are stored.

1	Switch off the measuring instrument.
2	Press the <M> key and hold it down.
3	Press the <ON/OFF> key. The display test appears briefly on the display. The measuring instrument then switches automatically to the setting of the baud rate.

Baud rate (Cond 340i)



4	Select the required Baud rate with <▲> <▼> .
5	Confirm with <RUN/ENTER> . <i>Int 3</i> appears on the display.

Calibration interval

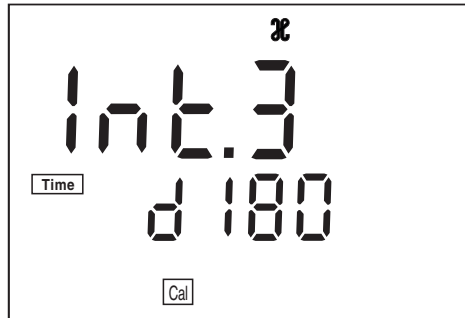

- 6 Set the required interval in days with <▲> <▼>.
- 7 Confirm with <RUN/ENTER>. *ARng* appears on the display.

**AutoRange
(automatic
selection of the
measurement
range)**

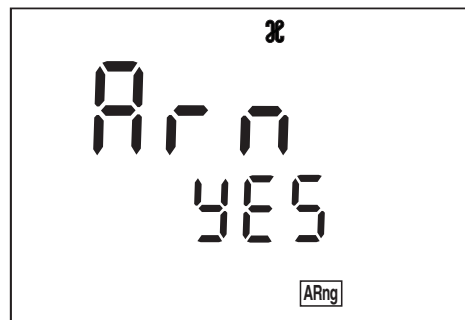

- 8 Using <▲> <▼>, switch between *no* and *YES*.
YES: Switch on AutoRange.
no: Switch off AutoRange.
- 9 Confirm with <RUN/ENTER>. *t25* appears on the display.

**Reference
temperature**

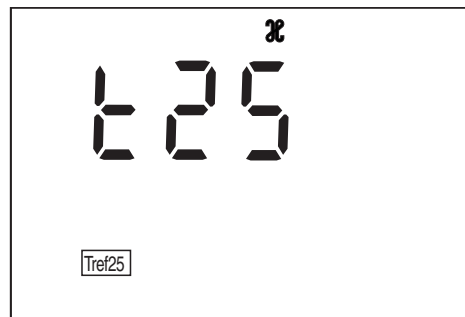

- 10 Using <▲> <▼>, switch between *t25* and *t20*.
- 11 Confirm with <RUN/ENTER>. *Cond* appears on the display.

Display of the measured value as conductivity / specific resistance

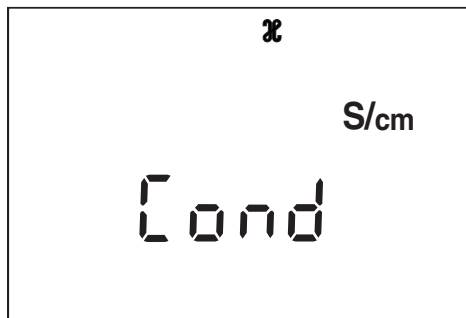

- 12 Using <▲> <▼>, switch between *S/cm* and *MΩcm*.
- 13 Confirm with <RUN/ENTER>. The date flashes on the display.

Date and time

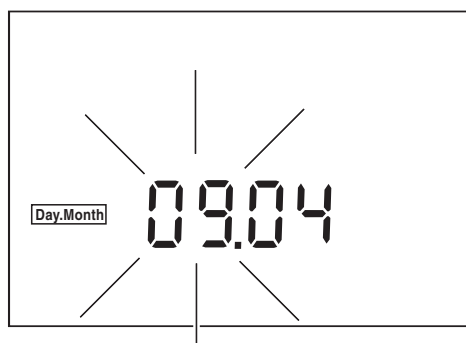

- 14 Set the date of the current day with <▲> <▼>.
- 15 Confirm with <RUN/ENTER>. The date (month) flashes in the display.
- 16 Set the current month with <▲> <▼>.
- 17 Confirm with <RUN/ENTER>. The year appears on the display.
- 18 Set the current year with <▲> <▼>.
- 19 Confirm with <RUN/ENTER>. The hours flash on the display.
- 20 Set the current time with <▲> <▼>.

- | | |
|----|---|
| 21 | Confirm with <RUN/ENTER> .
The minutes flash on the display. |
| 22 | Set the current time with <▲> <▼> . |
| 23 | Confirm with <RUN/ENTER> .
The measuring instrument automatically switches to the measuring mode. |

4.7 Reset

You can reset (initialize) the measurement parameters and the configuration parameters separately from one another.

Measurement parameters

The following measured parameters (\mathcal{X} *Inl*) are reset to the default condition:

Measuring mode	\mathcal{X}
Cell constant	0.475 cm ⁻¹ (calibrated) 0.475 cm ⁻¹ (set up)
Temperature compensation	nLF
Reference temperature	Tref25
Temperature coefficient of the linear temperature compensation	2.000 %/K
TDS factor	1.00



Note

The calibration data gets lost when the measuring parameters are reset. Recalibrate after performing a reset.

Configuration parameters

The following configuration parameters (*Inl*) are reset to the delivery status:

Baud rate	4800
Interval 1 (automatic save)	OFF
Interval 2 (for data transmission)	OFF

Resetting the measuring parameters

- 1 Press the <RUN/ENTER> key and hold it down.
- 2 Press the <CAL> key.

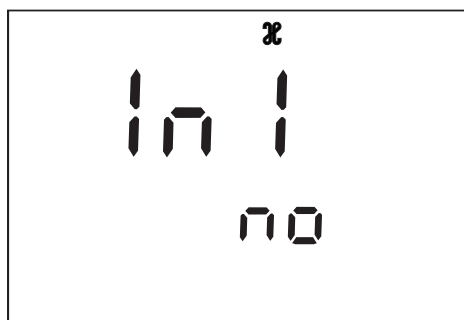

- | | |
|---|--|
| 3 | Using <▲> <▼>, switch between <i>no</i> and <i>YES</i> .
<i>YES</i> : Resetting the measuring parameters
<i>no</i> : Retaining settings. |
| 4 | Confirm with <RUN/ENTER>.
The measuring instrument switches to the configuration parameters. |

Resetting the configuration parameters



- | | |
|---|--|
| 5 | Using <▲> <▼>, switch between <i>no</i> and <i>YES</i> .
<i>YES</i> : Resetting the configuration parameters
<i>no</i> : Retaining settings. |
| 6 | Confirm with <RUN/ENTER>.
The measuring instrument automatically switches to the measuring mode. |

5 Maintenance, cleaning, disposal

5.1 Maintenance

The measuring instrument is almost maintenance-free. The only maintenance task is replacing the batteries. *LoBat* indicates that the batteries should be changed. The batteries are then largely depleted.

Replacing the batteries

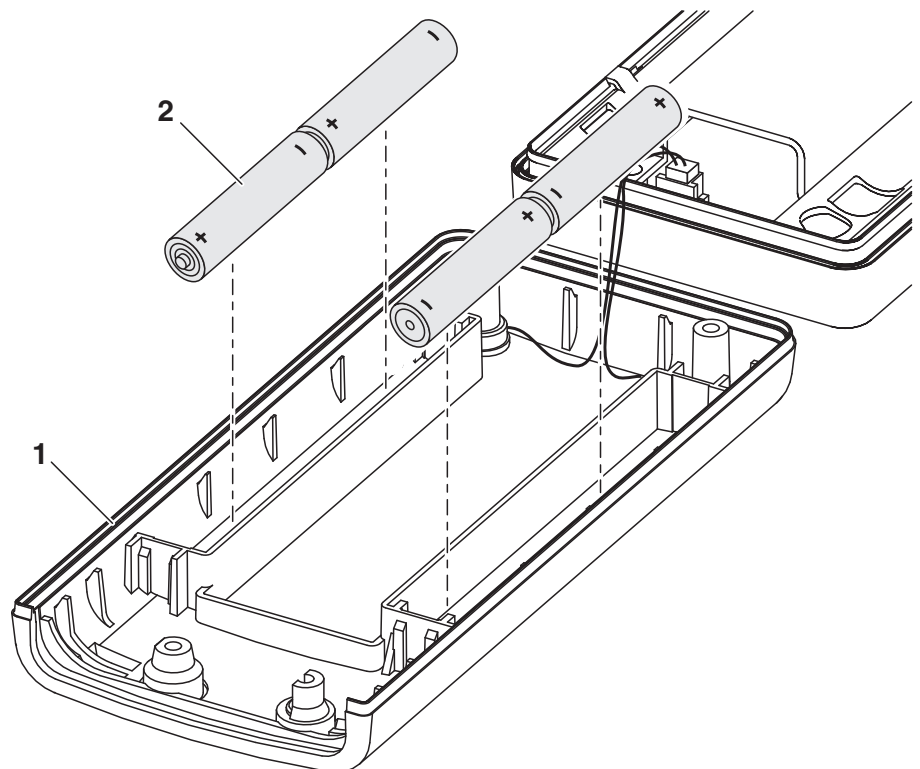

1	Open the housing after the instrument has been switched off: – Undo the four screws on the underside of the instrument – Pull down the lower cover (1).
2	If necessary, take the four depleted batteries (2) out of the battery compartment.
3	Place four new batteries (type Mignon AA) in the battery compartment.
4	Close the lower cover (1).



Warning

Make sure that the poles of the batteries are the right way round. The \pm signs on the batteries must correspond to the \pm signs in the battery compartment.
Only use leakproof alkaline manganese batteries.

**Note**

For the maintenance of the measuring cells, follow the corresponding operating manual.

5.2 Cleaning

Occasionally wipe the outside of the measuring instrument with a damp, lint-free cloth. Disinfect the housing with isopropanol as required.

**Warning**

The housing is made of a synthetic material (ABS). Thus, avoid contact with acetone and similar detergents that contain solvents. Remove any splashes immediately.

5.3 Disposal**Packing**

This measuring instrument is sent out in a protective transport packing. We recommend: Keep the packing material. The original packing protects the instrument against damage during transport.

Batteries

This note refers to the battery regulation that applies in the Federal Republic of Germany. We would ask end-consumers in other countries to follow their local statutory provisions.

**Note**

This instrument contains batteries. Batteries that have been removed must only be disposed of at the recycling facility set up for this purpose or via the retail outlet.

It is illegal to dispose of them in household refuse.

Measuring instrument

Dispose of the measuring instrument as electronic waste at an appropriate collection point. It is illegal to dispose of the instrument in household refuse.

6 What to do if...

LoBat display

Cause

- Batteries almost empty

Remedy

- Replace batteries
(see section 5.1 MAINTENANCE)

Instrument does not react to keystroke

Cause

- Operating condition undefined or EMC load unallowed

Remedy

- Processor reset:
Press the **<CAL>** and **<ON/OFF>** keys at the same time and release them again. The software version is displayed.

Error message **OFL**

Cause

The measured value lies outside the measuring range

- Measuring cell not connected
- Cable broken

Remedy

- Connect measuring cell
- Replace measuring cell

Error message **E3**

Cause

- Measuring cell contaminated
- Unsuitable calibration solution

Remedy

- Clean cell and replace it if necessary
- Check calibration solutions

Display **to**

Cause

- Time-out of the interface

Remedy

- Check the instrument that is connected

Probe symbol flashes

Cause

- Calibration interval expired

Remedy

- Recalibrate the measuring system

Message Stofull	Cause	Remedy
	– All memory locations are full	– Output data storage and clear data storage
You would like to know which software version is in the instrument	Cause	Remedy
	– e.g. question of the WTW service department	– Press the  key and switch on instrument. The software version is displayed.

7 Technical data

Dimensions and weight	Length [mm]	172
	Width [mm]	80
	Height [mm]	37
	Weight [kg]	Approx. 0.3
Mechanical structure	Type of protection	IP 66
Electrical safety	Protective class	III
Test certificates	cETLus, CE	
Ambient conditions	Storage	- 25 °C ... + 65 °C
	Operation	-10 °C ... + 55 °C
	Climatic class	2
Measuring ranges and resolution	κ [μS/cm]	0.000 ... 1.999 (only for cell constant = 0.010 cm ⁻¹)
		0.00 ... 19.99 (only at a cell const. = 0.010 cm ⁻¹ and cell const. = 0.090 ... 0.110 cm ⁻¹)
		0.0 ... 199.9
		0 ... 1999
	κ [mS/cm]	0.00 ... 19.99
		0.0 ... 199.9
		0 ... 500
Spec. resistance [MΩ*cm]	0.000 ... 1.999 0.00 ... 19.99 0.0 ... 199.9 0 ... 1999	
SAL	0.0 ... 70.0 according to the IOT table	
TDS [mg/l]	0 ... 1999 (Factor can be set between 0.40 ... 1.00)	
T [°C]	- 5.0 ... + 105.0	

Accuracy (± 1 digit)	∞	<p>No compensation: Accuracy ± 0.5 %</p> <p>Nonlinear compensation \boxed{nLF} : Accuracy Sample temperature ± 0.5 % 0 °C ... 35 °C ± 0.5 % 35 °C ... 50 °C according to EN 27 888; extended nLF function acc. to WTW measurements</p> <p>Linear compensation \boxed{Lin} : Accuracy Sample temperature ± 0.5 % 10 °C ... 75 °C (The accuracy percentage always refers to the measured value.)</p>
	SAL	<p>Range 0.0 ... 42.0</p> <p>Accuracy Sample temperature ± 0.1 5 °C ... 25 °C ± 0.2 25 °C ... 30 °C</p>
TDS [mg/l]	1	
T [°C]		<p>NTC 30: Accuracy ± 0.1</p> <p>PT 1000: Accuracy Operating temperature ± 0.5 0 °C ... 15 °C ± 0.1 15 °C ... 35 °C ± 1 35 °C ... 55 °C</p>
Cell constant, calibrating	C [cm ⁻¹]	0.450 ... 0.500 0.800 ... 1.200
Selecting the cell constant:	C [cm ⁻¹]	0.01 fixed 0.090 ... 0.110 0.250 ... 2.500
Reference temperature	Tref	Can be set to 20 °C or 25 °C
Temperature input	Manually [°C]	-5 ... +100

**Analog output
(only Cond 340i)**

Automatic switchover when the recorder is connected by the cable, AK 323.

Output signal	0 ... 1.999 V for range 0 ... 1999 digits
Accuracy	± 0.5 % of display value
Internal resistance	< 5 Ohm (current limited to max. 0.2 mA output current)

**Serial interface
(only Cond 340i)**

Automatic switchover when a PC or a printer is connected via the cable, AK 340/B or AK 325/S.

Type	RS 232, data output
Baud rate	Selectable 1200, 2400, 4800, 9600 baud
Data bits	8
Stop bit	2
Parity	None
Handshake	RTS/CTS + Xon/Xoff
Cable length	Max. 15m

Power supply

Batteries	4x1.5V alkali-manganese batteries, Type AA
Operational life	Approx. 3000 operating hours
Mains (only Cond 340i)	The following specifications apply to all plug-in power supplies: Connection max. Over-voltage category II Plug-in power supply unit (Euro, US , UK, Australian plug) FRIWO FW7555M/09, 15.1432 Friwo Part. No. 1822089 Input: 100 ... 240 V ~ / 50 ... 60 Hz / 400 mA Output: 9 V = / 1,5 A

**Guidelines
and norms used**

EMC	E.C. guideline 89/336/EEC EN 61326-1:1997 EN 61000-3-2 A14:2000 EN 61000-3-3:1995 FCC Class A
Instrument safety	E.C. guideline 73/23/EEC EN 61010-1 A2:1995

Climatic class	VDI/VDE 3540
Type of protection	EN 60529:1991

FCC Class A Equipment Statement

Note: This equipment has been tested and found to comply with the limits for a Class A digital device, pursuant to Part 15 of the FCC Rules. These limits are designed to provide reasonable protection against harmful interference when the equipment is operated in a commercial environment. This equipment generates, uses, and can radiate radio frequency energy and, if not installed and used in accordance with the instruction manual, may cause harmful interference to radio communications. Operation of this equipment in a residential area is likely to cause harmful interference in which case the user will be required to correct the interference at his own expense.

8 Lists

This chapter provides additional information and orientation aids.

Abbreviations

The list of abbreviations explains the indicators and the abbreviations that appear on the display and in the manual.

Specialist terms

The glossary briefly explains the meaning of the specialist terms. However, terms that should already be familiar to the target group are not described here.

Index

The index will help you to find the topics that you are looking for.

Abbreviations

κ	Conductivity value (international γ)
AR	AutoRead (drift control)
ARng	Automatic range switching Measuring instrument measures with highest resolution
C	Cell constant [cm^{-1}] (internat. k)
$^{\circ}\text{C}$	Temperature unit, degrees Celsius
Cal	Calibration
InI	Initialization Resets individual basic functions to the status they had on delivery
Lin	Linear temperature compensation
LoBat	Batteries almost empty (Low Battery)
nLF	Nonlinear temperature compensation
OFL	Display range exceeded (Overflow)
SELV	Safety Extra Low Voltage
TC	Temperature coefficient (internat. α)
TDS	Total Dissolved Solids
TP	Temperature measurement active (Temperature Probe)
$T_{\text{Ref}} 20/\text{T}20$	Reference temperature of 20 $^{\circ}\text{C}$
$T_{\text{Ref}} 25/\text{T}25$	Reference temperature of 25 $^{\circ}\text{C}$

Glossary

Adjusting	To manipulate a measuring system so that the relevant value (e. g. the displayed value) differs as little as possible from the correct value or a value that is regarded as correct, or that the difference remains within the tolerance.
AutoRange	Name of the automatic selection of the measuring range.
AutoRead	WTW name for a function to check the stability of the measured value.
Calibration	Comparing the value from a measuring system (e. g. the displayed value) to the correct value or a value that is regarded as correct. Often, this expression is also used when the measuring system is adjusted at the same time (see adjusting).
Cell constant, k	Characteristic quantity of a conductivity measuring cell, depending on the geometry.
Conductivity	Short form of the expression, specific electrical conductivity. It is a measured value of the ability of a substance to conduct an electric current. In water analysis, the electrical conductivity is a dimension for the ionized substances in a solution.
Conductometry	Name of the conductivity measuring technique.
Measured parameter	The measured parameter is the physical dimension determined by measuring, e. g. pH, conductivity or D. O. concentration.
Measured value	The measured value is the special value of a measured parameter to be determined. It is given as a combination of the numerical value and unit (e. g. 3 m; 0.5 s; 5.2 A; 373.15 K).
Measuring system	The measuring system comprises all the devices used for measuring, e. g. measuring instrument and probe. In addition, there is the cable and possibly an amplifier, terminal strip and armature.
Molality	Molality is the quantity (in Mol) of a dissolved substance in 1000 g solvent.
Reference temperature	Fixed temperature value to compare temperature-dependent measured values. For conductivity measurements, the measured value is converted to a conductivity value at a reference temperature of 20 °C or 25 °C.
Reset	Restoring the original condition of all settings of a measuring system.
Resistance	Short name for the specific electrolytic resistance. It corresponds to the reciprocal value of the electrical conductivity.
Resolution	Smallest difference between two measured values that can be displayed by a measuring instrument.

Salinity	The absolute salinity S_A of seawater corresponds to the relationship of the mass of dissolved salts to the mass of the solution (in g/Kg). In practice, this dimension cannot be measured directly. Therefore, the practical salinity is used for oceanographic monitoring. It is determined by measuring the electrical conductivity.
Salt content	General designation for the quantity of salt dissolved in water.
Slope	The slope of a linear calibration function.
Standard solution	The standard solution is a solution where the measured value is known by definition. It is used to calibrate a measuring system.
TDS	Total dissolved solids
TDS factor	In conductometric measurements, the measuring instrument calculates the total dissolved solids (TDS) from the electric conductivity of the test sample. For the calculation, a simple multiplication factor between 0.4 and 1.0 suffices. The exact factor depends on the quality of the water to be examined and has to be determined for each water type.
Temperature coefficient	Value of the slope of a linear temperature function.
Temperature compensation	Name of a function that considers the temperature influence on the measurement and converts it accordingly. Depending on the measured parameter to be determined, the temperature compensation functions in different ways. For conductometric measurements, the measured value is converted to a defined reference temperature. For potentiometric measurements, the slope value is adjusted to the temperature of the test sample but the measured value is not converted.
Temperature function	Name of a mathematical function expressing the temperature behavior of a test sample, a probe or part of a probe.
Test sample	Designation of the sample ready to be measured. Normally, a test sample is made by processing the original sample. The test sample and original sample are identical if the test sample was not processed.

Index**A**

Analog output 40
Authorized use 9
AutoRead 17

C

Calibration 18
Calibration protocol (340i) 18
Cell constant 18
 determine 20
 set manually 22
Conductivity 15
Conductivity/ Resistance 40
Connecting a printer 41
Connecting the plug-in power supply 12

D

Data record 29
Data transmission (interval) 39
Default condition 46
Display 8
Drift control 17

E

Energy saving feature 13
Error messages 51

I

Initial commissioning 11
Initialization 46
Interval
 data transmission 38
 save 31

K

Keys 7

L

Linear
 temperature compensation 27
LoBat 51

N

Nonlinear
 temperature compensation 26

O

Operating safety 10

P

Printing
 calibration protocol 18

R

Reference temperature (conductivity) 14
Remote control 41
Replacing the batteries 49
Reset 46
RS232 interface 41

S

Safety 9
Safety precautions 9
Salinity 15, 40
Save interval 31
Scope of delivery 11
Setting the baud rate 42
Setting the date 11, 44
Setting the time 11, 44

T

TDS 16, 40
TDS factor 16
Temperature compensation 25, 28
Temperature compensation (conductivity) 14
Temperature sensor
 Conductivity 14
Total dissolved solids 16



Wissenschaftlich-Technische Werkstätten GmbH

Dr.-Karl-Slevogt-Straße 1
D-82362 Weilheim

Germany

Tel: +49 (0) 881 183-0
+49 (0) 881 183-100
Fax: +49 (0) 881 183-420
E-Mail: Info@WTW.com
Internet: <http://www.WTW.com>